

**01**

version

# Proposal

**Biogas plant 450 tonnes stillage/day**



Date: 08/05/2024

Validity: 3month



# CONTENTS

---

Overview	3
Raw material potential	4
Biogas plant technical performances	5
Working principle	6
Technological process of biogas production	7
Main equipment	8
Reactor	9
Reactor central agitator	10
Pump equipment	11
Decanter	12
Filtrate tank	13
Side mixer	14
Spiral Heat Exchanger	15
Window with spotlight	16
Reagent tanks	17
Gasholder	18
Biogas dryer and cooler	19
Biogas compressor	20
Desulphurization system	21
Flare	22
Gas analyzer	23
Dry cooler	24
Heat supply system	25
Water supplying and sewerage system	26
Automation and electrical equipment	27
Sensors set	28
Laboratory	29
Specification list	30
Appendixes	35
Appendix 1. Material flow diagram	
Appendix 2. Basic diagram	
Appendix 3. Plan of biogas plant	
Appendix 4. Electric power consumption	
Appendix 5. Prices for equipment and Zorg' services	



## OVERVIEW

Zorg Biogas offers a solution to process stillage from ethanol distillery into biogas. The produced biogas is used to replace natural gas in the existing boiler. A proven technology of vertical CSTR reactor with a central agitator is used.

The vertical shape provides the optimal mass and heat transfer, as a result the biogas plant consumes very little electric energy. To compare different concepts of biogas plant it is necessary to pay attention not only to the price, but also to the quality and small but very important details. The temperature is maintained with an accuracy of  $0,1^{\circ}\text{C}$ . The roof of the reactor and next two rows of rings are made from stainless steel. There is a double filtration of biogas, which save burners life. The biogas plant is equipped with a modern laboratory. Biogas plants has a lot of features, which are known only to the experienced company. For example, operational temperature, foam safety valves, micro-elements and etc.

The offered biogas plant processes 450 tonnes stillage a day. The produced biogas will replace 13700 m<sup>3</sup>/day natural gas or any other fuel with 171 MWh thermal energy a day or 590 MMBTU per day.

### Raw material potential

Substrate	Quantity (tonnes/day)	Quantity (tonnes/year)	DM content (%)	DM quantity (tonnes / day)	ODM quantity (tonnes / day)	ODM content (%)	DM content (%)	DM quantity (tonnes / day)	ODM quantity (tonnes / day)	Biogas yield (m <sup>3</sup> / tonneDDM)	Biogas (m <sup>3</sup> / day)	Methane content (%)	Biogas (m <sup>3</sup> / year)
Stillage	450	164 250	10	45.0	41.4	92	10	45.0	41.4	670	27 738	60	10 124 370

## Biogas plant technical performances

Characteristics	Values	Figures
Number of digesters	units	2
Digester volume Work Overall	m <sup>3</sup>	5965 6228
Organic load	kgODM/ m <sup>3</sup>	3.47
Hydraulic retention time	days	28
Temperature in the digester	°C	52
Overall dimensions of the digester (diameter / height)	m	20.49/18.90
Number of gasholder	units	1
Gasholder volume	m <sup>3</sup>	860
Overall dimensions of the gasholder (diameter / height)	m	12.5/9.3



# WORKING PRINCIPLE

## Biogas plant working principle



The technology is based on the biochemical conversion of organic materials from high molecular weight compounds to low molecular weight compounds. The first stage of this process is hydrolysis. Hydrolysis produces organic acids and alcohols. Organic compounds + H<sub>2</sub>O → C<sub>5</sub>H<sub>7</sub>N<sub>0</sub><sub>2</sub>+H-CO<sub>3</sub>.

Further conversion of obtained dissolved compounds like organic acids and alcohols (C<sub>5</sub>H<sub>7</sub>N<sub>0</sub><sub>2</sub>,HCO<sub>3</sub>) into gases - CH<sub>4</sub>, CO<sub>2</sub>. C<sub>5</sub>H<sub>7</sub>N<sub>0</sub><sub>2</sub> + HCO<sub>3</sub> + H<sub>2</sub>O → CH<sub>4</sub>+CO<sub>2</sub>+NH<sub>4</sub>.

Biological process of consecutive (phasic) conversion of organic compounds take place in anaerobic environment i.e. in oxygen-free tank (biological reactor). At the first stage of fermentation, substrate hydrolysis take place under acidogenic bacteria influence. At the second stage, elementary organic compounds come through hydrolysis oxidation by means of hetero-acidogenic bacteria with production of acetate, carbon dioxide, and free hydrogen. The other part of the organic

compound including acetate forms C<sub>1</sub> compounds (elementary organic acids). Produced substances are the feedstock for methanogenic bacteria of the third type. This stage flows in two processes of A and B type the character which depends on caused by different bacteria type. These two types of bacteria convert the compound obtained during the first and second stages into methane CH<sub>4</sub>, water H<sub>2</sub>O and carbon dioxide CO<sub>2</sub>. Methanogenic bacteria are more sensitive to the living environment compared to acidogenic bacteria. They require a complete anaerobic environment and a longer reproduction period. The speed and scale of anaerobic fermentation depends on bacteria metabolic activity. That is why the biogas plant chemical process includes hydrolysis stage, oxidation, and methanization stage. For that kind of substrate, these processes take place in the same reactor

## Technological process of biogas production

Stillage is loaded directly into reactors. In the reactors, the substrate is fermented at temperature of + 52 C. Thus, a constant temperature is maintained in the digester throughout the entire fermentation process. The substrate is mixed with a central vertical agitator. The average fermentation time is 28 days. Biogas rises and collects under the conical arch of the digesters. To prevent excess pressure above acceptable, the digesters are equipped with a safety valves that starts to operate at a pressure of 10 mbar and releases biogas into the atmosphere.

The biogas from the digesters enter to an external gasholder. In the gasholder, pressure and biogas composition are averaged. Through pipelines, biogas from gasholder enters the biogas cooling system. The cooling system is a heat exchanger with its own cooling circuit. After cooling the biogas to + 20 ° C, condensate formed is removed from the cooling system. After cooling, the biogas is heated to + 35..40 ° C to reduce the relative humidity of the biogas.

After cooling biogas flows through the pipeline to the compressor, where its pres-

sure rises to 80-150 mbar for supplying to purification from hydrogen sulphide in activated carbon columns and then can be use to replace natural gas in existing boiler plant. All technological processes are controlled and operated by automatic system. Biogas plant work is visualized at central control room monitor. The control room is equipped with central control unit, which allows switch of any biogas plant module into automatic or manual mode with local or remote control.

# MAIN EQUIPMENT







## Reactor (R-01, R-02)

Reactor is an important part of a biogas plant made of enameled sheet metal. The steel digester is installed on a concrete basis. A layer of enamel protects the surface of the entire metal structure. The enamel is vitreous and very resistant to aggressive pH and mechanical damage. Enameled digester assembled from steel segments. Such a digester is quickly and safely mounted.

Steel panels are joined on bolted joints with a special sealant. The enamel coating is layered according to the PUESTA method. This is a special powder that is laid in layers by electrostatic attraction. Thus, uniformity of coating, density and smooth-

ness are achieved. Bolts made of stainless steel. All elements (flanges, etc.) are connected through an EPDM membrane to protect the enamel.

To reduce heat consumption and maintain a constant temperature, the digester is isolated. Outside the digester is coated with a decorative coating.

### Specifications

**Height :** 20.49 m

**Diameter :** 18.90 m

**The total volume :** 6228 m<sup>3</sup>

**Quantity:** 2 pcs.

**Plates (tank wall enamelled, roof)**

**Flange, nozzle, lap joint flanges outside**

**2 off control glass 2 x DN 250 with water flush**

**Ex light**

**Manhole**

**Ladder, stair and walkway**

**Brackets and clamps for pipe along tank edge (internal/external)**



## Reactor`s central agitator (AG-01, AG-02)

The agitator is fixed to the center of the rigid overlap of the fermenter. Mixer blades are designed in different directions. This design of the blades helps to create a lifting force that lifts the substrate from the bottom of the digester to the top of the tank. The upper blades rotate distributing the substrate along the digester, directing the flow downward. The agitator works constantly, mixing the substrate in the digester all the time.

### Specifications

---

Engine power:

N=27 kW

Quantity (per digester):

2 pcs

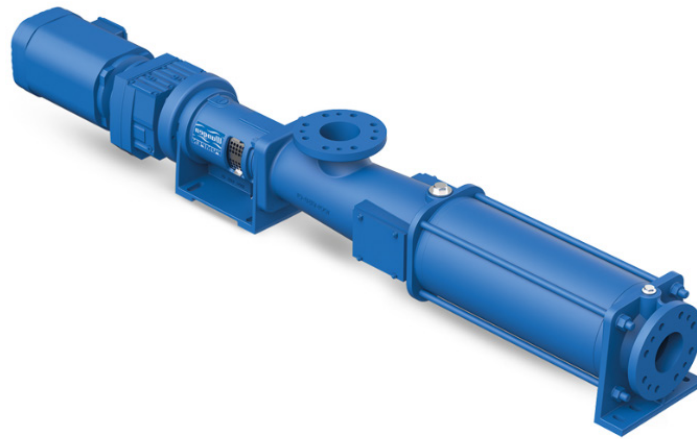

## Pump equipment (PU-01...PU-07)

Pumps are used to transport substrate to the equipment and facilities in the biogas plant and away. Kinematic viscosity is a real physical factor that influences pump curves, and thus the choice of pump. Viscosity is essentially resistance to flow and this has implications for pumps. Fluid viscosity or thickness will affect how it will behave in a pump. Screw pumps are used for pumping flowable thin sludge, excess sludge and mechanically thickened sludge and conveying the substrates with their mostly high dry substance contents (DS) containing up to 13% dry matter. Optimum pumping results are guaranteed by the flow-optimized suction housing and a constant joint diameter which prevents the plaiting of long fibers.

### Specifications

#### Digested Substrate pump (PU-01, PU-02)

Flow rate:	50 m <sup>3</sup> /hour
Engine power:	15 kW
Quantity:	2 pcs

#### Substrate circulation pump (PU-03, PU-04)

Flow rate:	35 m <sup>3</sup> /hour
Engine power:	11 kW
Quantity:	2 pcs

#### Filtrate pump (PU-05)

Flow rate:	50 m <sup>3</sup> /hour
Engine power:	15 kW
Quantity:	1 pcs

#### Substrate feed pump (PU-06, PU-07)

Flow rate:	50 m <sup>3</sup> /hour
Engine power:	15 kW
Quantity:	2 pcs



## Decanter

This deep-pond 3-phase decanter centrifuge has been customized for clear clarification, liquid separation and solids dewatering. The solid-wall bowl has a cylindrical section for efficient clarification of the liquids and a conical section for drying the solids. Due to the centrifugal forces, the solids are flung onto the inner bowl shell and are transported by the scroll to the solids discharge. On decanter the heavy or light liquid phase is discharged under pressure by use of a centrifugal pump while the other liquid phase is discharged by drain tubes. The housing consists of a frame with supporting feet, protective plates and catchers for the discharged phases.

## Specifications

---

<b>Flow rate:</b>	50 m <sup>3</sup> /hour
<b>Engine power:</b>	25.0 kW
<b>Quantity:</b>	2 pcs



## Filtrate tank (FT-01)

Reservoir for reception of liquid kinds of raw materials. Tank is equipped with level sensors and side agitators for mixing raw materials.

### Specifications

---

<b>Diameter:</b>	9.39 m
<b>Height</b>	4.27 m
<b>Total volume:</b>	296 m <sup>3</sup>
<b>Quantity:</b>	1 psc

**Plates (tank wall enamelled, roof)**

**Flange, nozzle, lap joint flanges outside**

**Control glass**

**Ex light**

**Manhole**

**Ladder, stair and walkway**

**Brackets and clamps for pipe along tank edge (internal/external)**



## Side Spiral agitator (AG-03)

Side mixers are used in biogas reactors and receiving tanks for mixing medium and low viscosity substrates. When installed on a metal tank, the stirrer is attached to a support column. The agitator drive is located outside, and a shaft with a screw goes into the reactor through a flange installed in the wall. Installation through a flange prevents the transfer of forces from the agitator to the tank walls.

The side agitator of this series has an installed motor with a power of 15 to 22 kW, which allows it to mix a substrate with a volume of up to 31,800 m<sup>3</sup>/h. Suitable for use in aggressive environments with a dry matter content of up to 11 %. The special design of the shovel-like blades works good both with mixing different types of substrates and breaking up floating layers and crust.

## Specifications

---

**Nominal power:**

N= 11kW

**Quantity:**

1 psc





## Spiral Heat Exchanger (HE-01, HE-02)

Using as modular design for slurry, sludge and biological mass and for mediums that are badly contaminated and burden by solids with a distinctive fouling behavior. The main component of the Spiral Heat Exchanger is an aluminum cast member made of a no corrosive alloy. A number of left-handed and right-handed components, one on top of the other, from a compact, high-capacity heat exchanger. To avoid hard alteration of the direction of the flow, the spiral channel has an anti-clockwise curvature (left-hand element) and a clockwise curvature (right-hand element).

### Specifications

---

<b>Volumetric capacity</b>	5 to 60 m <sup>3</sup> / h
<b>Temperature</b>	up to 90 ° C;
<b>Working pressure</b>	at 4 bar
<b>Capacity of the heat exchanger</b>	150-300 kW
<b>Quantity</b>	2 pcs



## Window with spotlight (SG-01, SG-02)

Inspection windows are designed for visual control of processes inside the fermenter and post-digester. Spotlights were made in explosion-proof with automatic disconnection. Inspection windows are equipped with a cleaning washing system.

### Specifications

---

Inspection windows Ø300  
Spotlight VISULUX UL50 -G -H  
230V, 50W, IP65  
Quantity: 3 pcs





## Reagent tanks

Reservoir for reception of liquid kinds of reagents. The tank is a system ready to instal with automation and control cabinet to manage proceses from filling, mixing to discharging by pump. The tank is manufactured with quality plastics, such as PE, PP, PVDF, and PVC. Possible to use in the different of climate zones and for contact with the most aggressive media. Temperature resistant and use from  $-40^{\circ}\text{C}$  to over  $+100^{\circ}\text{C}$ . Pressure and impact resistant welding and adhesive joints - created according to DVS guidelines - are just as resistant as the sheet material itself.

Electrically insulated or conductive – use of conductive materials for select-ed applications to avoid static electricity possible.

### Specifications

#### Iron chloride tank

<b>Diameter:</b>	1,6 m
<b>Height</b>	3,2 m
<b>Total volume:</b>	8.0 m <sup>3</sup>
<b>Quantity:</b>	1 pcs.

#### Anti-foam reagent tank

<b>Diameter:</b>	3.4 m
<b>Height</b>	4.9 m
<b>Total volume:</b>	40 m <sup>3</sup>
<b>Quantity:</b>	1 pcs.



## Gasholder (GH-01)

The gasholder provides for biogas storage and for equalizing pressure and biogas composition. The gasholder system has a two-layer construction. The external material consists of a weather-proof film of PVC-coated polyester fabrics with UV protection. Both sides are finished with an external N/5cm, internal membrane PELD (gasholder) membrane.

The gasholder has a methane permeation maximum of  $260 \text{ cm}^3/\text{m}^2 \cdot 1 \text{ bar}$  biogas resistance. The gasholder film temperature range allows operation from  $-30^\circ\text{C}$  to  $+60^\circ\text{C}$ .

The internal film is stretched under normal biogas pressure. Air is blown into the space between the external and internal membranes to pressurize the internal membrane and form the shape of the external membrane.

The biogas pressure in the gasholder is 2-5 mbar. The membranes are designed and cut out on NC machines. Welding is executed by high frequency currents. These steps yield substantial improvements for quality and service life compared to hand-made membranes welded by standard welding equipment.

To prevent damage to the gasholder as a result of overpressure conditions, a safety valve is installed. To survey the internal membrane, an inspection window is installed on the external membrane.

## Specifications

<b>Height :</b>	9.3 m
<b>Diameter :</b>	12.5 m
<b>The total volume :</b>	860 m <sup>3</sup>
<b>Quantity:</b>	1pcs

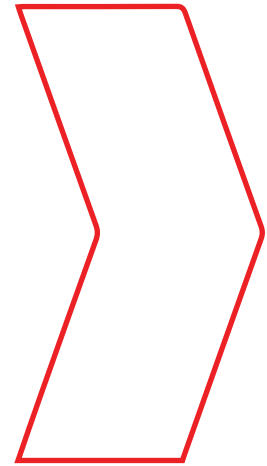

## Biogas dryer and cooling (CHL-01)

Biogas dryer and cooling are provided with special equipment as GAS COOLER and AIR-COOLED LIQUID CHILLER. Biogas plants thanks to an extensive range of dedicated Biogas solutions, low pressure heat exchangers, a comprehensive range of water chillers and RWD Dry Coolers. Designed as one-way shell-and-tube heat exchanger. Process gas inside of the tubes; cooling water in the shell.

All parts in contact with the process gas made of stainless steel 316Ti or 316L; heat exchanger shell made of stainless steel/ Designed with gas outlet chamber outlet connection radial; inspection opening axial. Official acceptance according to PED 2014/68/EU in accordance with ADMerkblätter and factory pressure test.

### Specifications (CHL-01...CHL-03)

<b>Gas volume flow</b>	1200 m <sup>3</sup> / h
<b>Gas inlet temperature</b>	+55 C
<b>Gas outlet temperature</b>	+10C
<b>Engine power</b>	36 kW
<b>Quantity:</b>	1 pcs



## Biogas compressor (BC-01, BC-02)

Biogas blower is a device used to move gas and increase pressure thanks to a rotating impeller within a toroidal channel, so there is a progressive increase of energy. Blower is used to transporting biogas from gasholder storage to consumer (cogeneration power plant in our case)

### Specifications

---

Flow rate	1300 m <sup>3</sup> /h
Pressure	150 mbar
Engine	16 kW
Quantity	2 pcs



## Desulphurization system

The desulphurization system is a 2-step system. Stage 1 is adding Iron Chloride. After 1-st step the sulphur concentration is 80 ppm. Stage 2 - activated charcoal filtration, as activated charcoal has the capability to absorb sulfur. After passing through activated charcoal filters, the sulfur concentration is reduced to 0 ppm

### Specifications

---

The volume of charcoal	500 kg
Numbers of charcoal columns	2 pcs

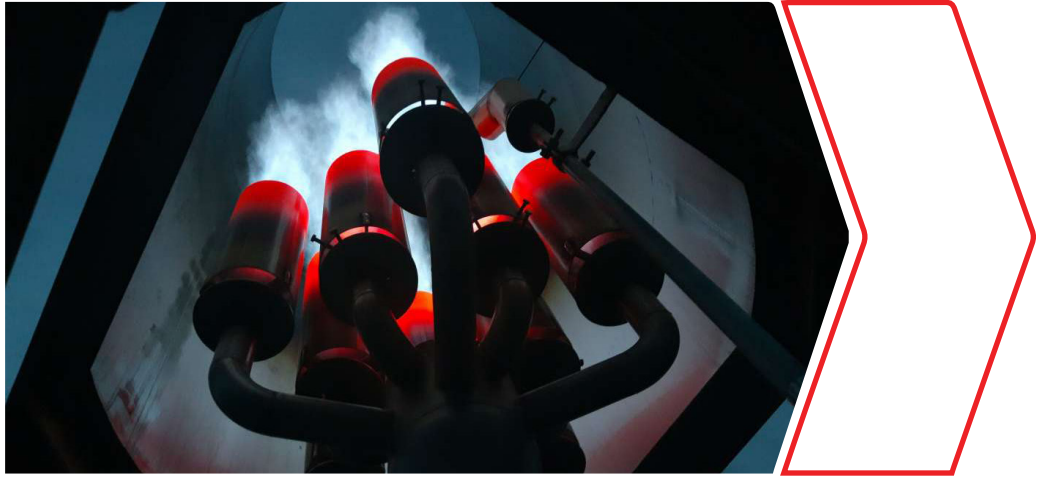

## Flare (BF-01)

The flare is designed for the temporary or periodical complete combustion of the biogas produced by biogas plants without the possibility of its use as an energy source. The burn system consists of a burner and additional equipment. The burner is designed on the principle of injection and consists of a combustion nozzle with an injector with an air supply control system, flame protection tube, fitting and burner control system. The biogas combustion system is made of stainless steel.

The supporting structure holds the burner and vertically mounted socket. The burn control system is installed in a case, which is mounted on the supporting structure of the combustion system and contains all the elements for monitoring and controlling ignition and flame.

## Specifications

---

**Flow rate** 1200 m<sup>3</sup>/h

**Quantity** 1 pcs





## Gas analyzer (CH<sub>4</sub>, CO<sub>2</sub>, H<sub>2</sub>S, O<sub>2</sub>) (GA-01)

Gas analyzer - a measuring device to determine the qualitative and quantitative composition of the gas mixture. In a biogas plant's installed absorption gas analyzers, biogas mixture components are absorbed sequentially with various reagents. Automatic gas analyzers continuously measure any physical or physicochemical characteristics of the gas mixture or its individual components. Operation is based on physical methods of analysis, including auxiliary chemical reactions.

### Specifications

---

#### Set includes

- Device for wall mounting
- LCD display menu
- Flow meter / control valve
- Sensors

Defined gases methane % (CH<sub>4</sub>), carbon dioxide % (CO<sub>2</sub>), hydrogen sulfide ppm (H<sub>2</sub>S)



## Dry cooler (DC-01, DC-02)

The device is designed to cool the heat-carrier in heat supply system. When using highly temperature substrates, there is a chance of uncontrolled self-heating of the digester. The cooler is connected to the heating pipes, and when it is active according to temperature sensors, the same lines of heating supply are used. One cooler works with related spiral heat exchanger to cool the input substrates. Another one works with second heat exchanger to control temperature inside the digester.

### Specifications

---

<b>Power (cooling)</b>	100 kW
<b>Engine power:</b>	6.0 kW
<b>Quantity:</b>	2 pcs





## Heating system

The heating equipment is used for biogas plant heating and for sustaining a constant temperature in the fermenter. The heating equipment includes circulation pumps, heat exchangers, heating manifolds, and tubes. The heat from the boiler is transferred to biogas plant walls by using a heat exchanger and is pumped through the interior of the biogas plant by circulation pumps. The system prepares water with added ethyl glycol. The inlet and outlet temperature in the fermenter are 60C and 40C respectively.

### Specifications

---

Circulating pump feeding heat carrier  
Flow 12 m<sup>3</sup> / h;  
Pressure 1.1 bar  
Engine 3.5 kW

Circulating pump feeding heat carrier  
Flow 0.6 m<sup>3</sup> / h;  
Pressure 1 bar,  
Engine 0.165 kW

The pumping station feeding propylene glycol  
Flow 1,0m<sup>3</sup> / h;  
Pressure 4 bar,  
Engine 0.775 kW

# Water supplying and sewerage system



The water supply system provides biogas plant with water for technological needs, water for heating-cooling system, water for drinking and domestic use, and water for fire safety systems. As used, centrifugal single-stage pumps are the main pumping elements. These pumps are designed for pumping wastewater, water for drinking and domestic use, and sewage.

Pressure Boosting Systems are designed for pure water pressure boosting in industrial plants. The booster is comprised of 2 to 3 pumps connected in parallel and installed on a common base frame and provided with all required fittings.

## Specifications

---

### Water supply pump

Pressure	2.5 bar
Flow	25 m <sup>3</sup> /h
Engine	3.0 kW

### Submersible pump

Pressure	1.1 bar
Flow	15 m <sup>3</sup> / h
Engine	3,5 kW

### Submersible pump with power cable

Pressure	1.1 bar
Flow	1,7l / s
Engine	0,9 kW

### Equipment

- Pump case control
- Stove-base
- gauges
- Check valves
- Float switches
- Brackets
- Valves

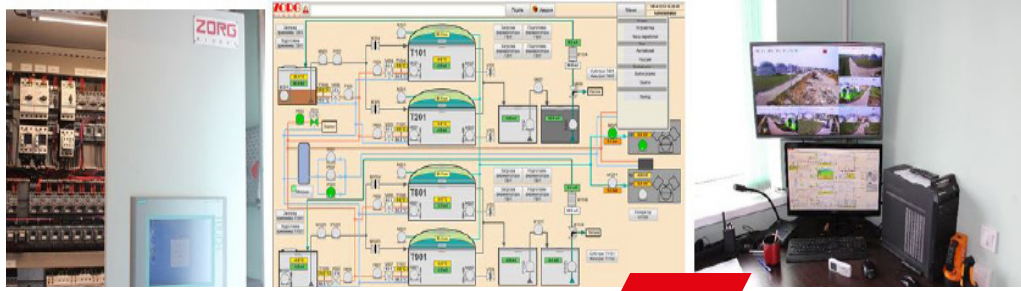

## Automation and electrical equipment

Process control equipment is used for supervision and regulation operation of the plant and for the limitation of damage. In case of emergency (for example, breakdown of the electrical power supply) the biogas plant is automatically transferred to safe operating conditions by the process instrumentation. Critical electrically driven devices are supplied with emergency power. An automatic system allows the supervision of the plant in real time and to recognize and correct aberrations immediately; to run the plant at its optimum saving resources and costs; and to record for the electronic database operation parameters. The automatic system consists of a control cabinet and sensors for parameter control of technological processes and execution devices.

The control cabinet is designed based on the industrial controller Siemens CPU315-DP2, using periphery distributing system Simatic ET200S, and operator panel OP277 Touch with touch-sensitive controls. Communications is executed by PROFIBUS and MPI with physical interface RS-485. The control program is designed based on the Simatic Step7. The control cabinet is a modular design. The upper part has a power box with central and front-end processor. The periphery distributing system, Simatic ET200S, is installed with input - output units. The lower part with interface relay and clips is installed for connecting execution devices. The entire plant is controlled by a single operator.

### Specifications

---

**Incoming control case with automatic set ASE-1, 2, 3**  
**Base Siemens CPU315-DP2 controller**  
**Peripherals Simatic ET200S**  
**Control panel OP277 touchscreen**  
**Communication PROFIBUS and MPI**  
**Interface RS-485**  
**Control system Simatic Step7**



## Sensors

Sensors are used to measure physical quantities (temperature, pressure, level of moisture) data collection.

## Specifications

---

Conductometric sensor  
Pressure Sensor / level  
Ultrasonic sensor  
Gas Pressure Sensor  
Temperature converters with protective sleeves  
The moisture sensor and the gas temperature



## Laboratory

Monitoring and control of parameters of raw materials and fermentation processes is important for the efficient operation of a biogas plant. The laboratory allows you to assess the content of dry matter in the input raw materials, fermented mass, determine the ratio of volatile organic acids to total inorganic carbon (FOS/TAC parameter), determine the degree of substrate fermentation in fermenters, the level of biogas output, and evaluate the efficiency of separator.

## Equipment

---

**Analytical scales**  
**Moisture analyzer**  
**Automatic titrator**  
**Laboratory pH meter**  
**Centrifuge**  
**A set of flasks**

# SPECIFICATION LIST



Nº	Equipment	Characteristic	Quantity
<b>1</b>	<b>Filtrate tank (steel enamel tank)</b>	<b>V=296m<sup>3</sup></b>	<b>1</b>
1.1	Manholes	set	1
1.2	Flanges to connection engineering communication	set	1
1.3	Service sites (for mixers gear, valves and connections)	set	1
1.4	Fixing for engineering communication	set	1
<b>2</b>	<b>Side Spiral agitator</b>	<b>N=11 kW</b>	<b>1</b>
2.1	Three phase motor, pressure-proof		1
2.2	Belt drive unit		1
2.3	Double acting mechanical seal		1
2.4	PTC motor control		1
2.5	Base-frame for the assembly		1
<b>3</b>	<b>Reactor (steel enamel tank)</b>	<b>V=6287 m<sup>3</sup></b>	<b>2</b>
3.1	Windows with spotlight, complete, disassembled	set	2
3.2	Flanges to connection engineering communication	set	2
3.3	Service sites (for mixers gear, valves and connections)	set	2
3.4	Fixing for engineering communication	set	2
<b>4</b>	<b>Reactor` s vertical agitator</b>	<b>N=27kW</b>	<b>2</b>
4.1	Airtight motor gearbox		2
4.2	Hydraulic screw (wear-resistant steel)		2
4.3	Shaft (adapted to the height of the fermenter)		2
4.5	Frequency converter		2
<b>5</b>	<b>Circulation substrate pump</b>	<b>Q=45 m<sup>3</sup>/h</b>	<b>2</b>
<b>6</b>	<b>External heat exchanger</b>	<b>150 kW</b>	<b>2</b>

Nº	Equipment	Characteristic	Q-ty
7	<b>Digested substrate pump</b>	<b>Q=50 m<sup>3</sup>/h</b>	<b>2</b>
8	<b>Filtrate pump</b>	<b>Q=50 m<sup>3</sup>/h N=18.5 kW</b>	<b>1</b>
9	<b>PVC external gas holder</b>	<b>Ø12,5m</b>	<b>1</b>
9.1	Weather protection film	Ø12.5 m	1
9.2	Gasholder film PELD methane permeation max.260 cm <sup>3</sup> /m <sup>2</sup> *d*1 bar, 650 N/5cm biogas resistant		1
9.3	Air blower	16A, 0,5kW	1
9.5	Excess and minimum pressure valve		1
9.6	Dome level sensor		1
9.7	Mounting system		1
9.8	Accessories	set	1
10	<b>Digester safety valve</b>		<b>2</b>
11	<b>Biogas compressor</b>	<b>Q=1300 m<sup>3</sup>/h N=16 kW</b>	<b>2</b>
12	<b>Biogas Cooling System</b>	<b>1200 m<sup>3</sup>/h</b>	<b>1</b>
12.1	Chiller		1
12.2	Heat exchanger		1
12.3	Polypropylene glycol tank		1
13	<b>Desulphurisation system</b>		<b>set</b>
13.1	Filter with activated charcoal	500 kg	2
14	<b>Biogas analyzer (CH<sub>4</sub> , CO<sub>2</sub> , H<sub>2</sub>S )</b>		<b>set</b>
15	<b>Electromagnetic flow meter</b>		<b>1</b>



Nº	Equipment	Characteristic	Q-ty
<b>16</b>	<b>Flare</b>	<b>1200 m³/h</b>	<b>1</b>
16.1	Compressor		1
16.2	Manual locking element		1
16.3	Deflagration fuse		1
16.4	On-site control cabinet		1
16.5	Auto ignition system		1
16.6	Auto Main Gas Solenoid Valve		1
<b>17</b>	<b>The heat supply system</b>		<b>1</b>
17.1	Diaphragm expansion tank	V=1000 l P=6Bar T=120°C	1
17.2	Circulating pump for supplying heat carrier	Q=12 m³/h N=3,5 kW	2
17.3	Circulation pump for supplying heating water to the office building	N=0,165 kW	1
<b>18</b>	<b>Dry cooler</b>	<b>100kw heat pow.</b>	<b>2</b>
<b>19</b>	<b>Automation with electrical equipment complete, disassembled</b>		<b>1</b>
19.1	Incoming distribution cabinet with a set of automation DB-1		1
19.2	Incoming distribution cabinet with a set of automation DB-2		1
19.3	Incoming distribution cabinet with a set of automation DB-3		1
<b>20</b>	<b>Sensor set</b>		<b>1</b>
21.1	Conductivity sensor	31SCM50	3
21.2	Pressure / level sensor	SEN-3251 B025 G1 1Bar	6
21.3	Ultrasonic sensor	SPA-380-08	3
21.4	Gas pressure sensor	G1/2 0,4Bar	3

Nº	Equipment	Characteristic	Q-ty
21.5	Thermal converter		3
21.6	Thermowells for thermocouples	TR10-B	3
21.7	Thermal converter heating circuit	TR3	3
21.8	Substrate pressure sensor	G1 4Bar	5
21.9	Substrate pressure sensor	G1 2,5Bar	5
21.10	Coolant pressure sensor	G1/2 6Bar	2
21.11	Immersion level sensor	LS-10 0,6Bar 4-20 mA	4
21.12	Humidity and gas temperature sensor	ESFTF-I	3

# APPENDIXES



# Material flow diagram

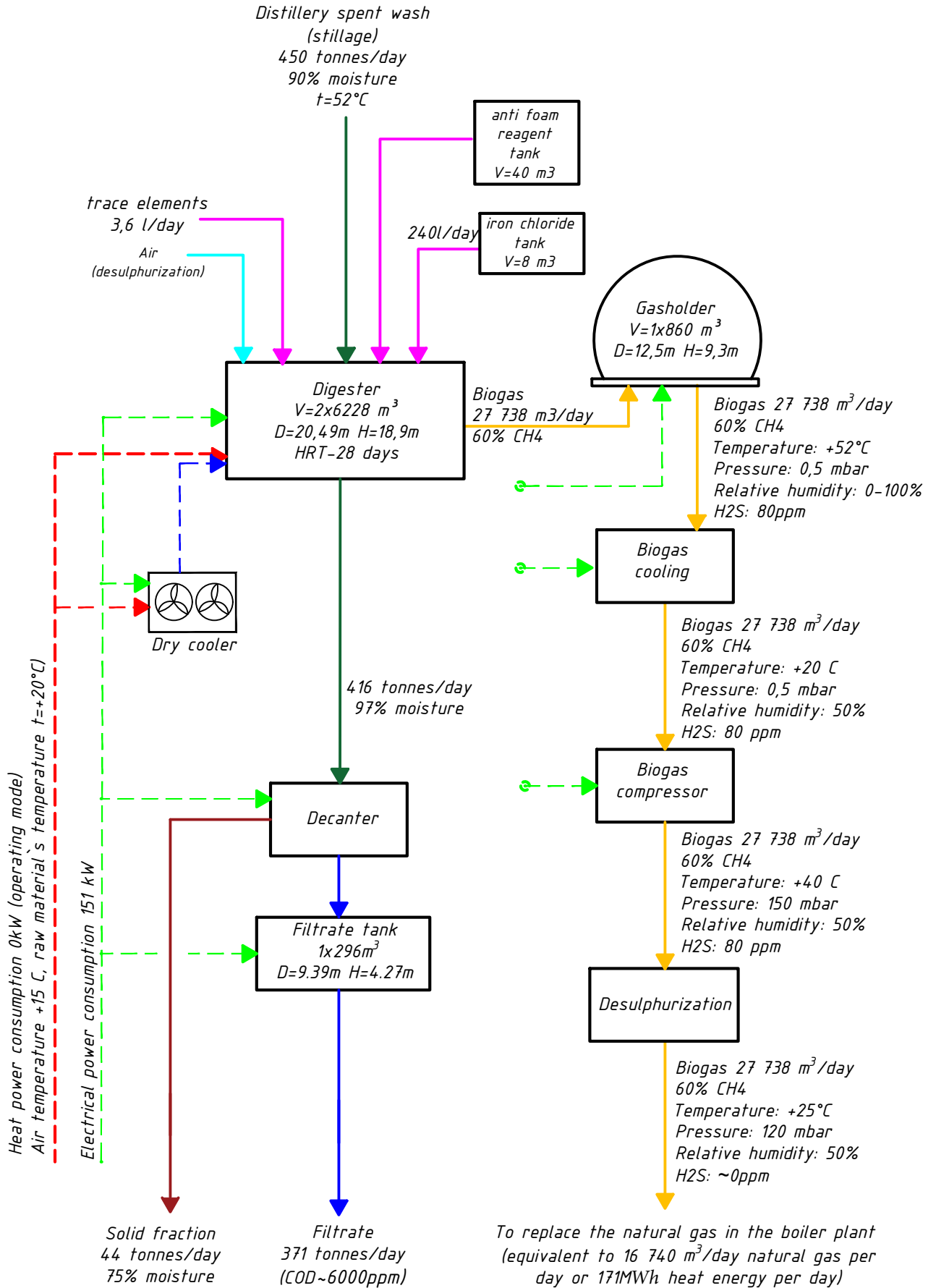

Explication

N/№	Name	Quantity
AG-01, AG-02	Reactor's central agitator	2
AG-03	Side agitator in the filtrate tank	1
SV-01, SV-02	Safety valve	2
SG-01, SG-02	Inspection windows	2
PU-01, PU-02	Digested substrate pump	2
PU-03, PU-04	Substrate circulation pump	2
PU-05	Filtrate pump	1
PU-06, PU-07	Substrate feed pump	2
HE-01, HE-02	Heat exchanger of digester	2
GH-01	Gasholder	1
CHL-01	Biogas cooling system	1
BC-01, BC-02	Biogas blower	2
CF-01, CF-02	Desulphurisation system	2
BG-01	Biogas analyzer	1
FM-01	Biogas flow meter	1
BF-01	Biogas flare	1
DC-01, DC-02	Dry cooler of digesters	2

Structure

N/№	Name	Quantity
R-01, R-02	Reactor	2
FT-01	Filtrate tank	1
HS-01	Heat sub-station	1
AFR-01	Anti-foam reagent tank	1
ICR-01	Iron chloride tank	1

Basic diagram

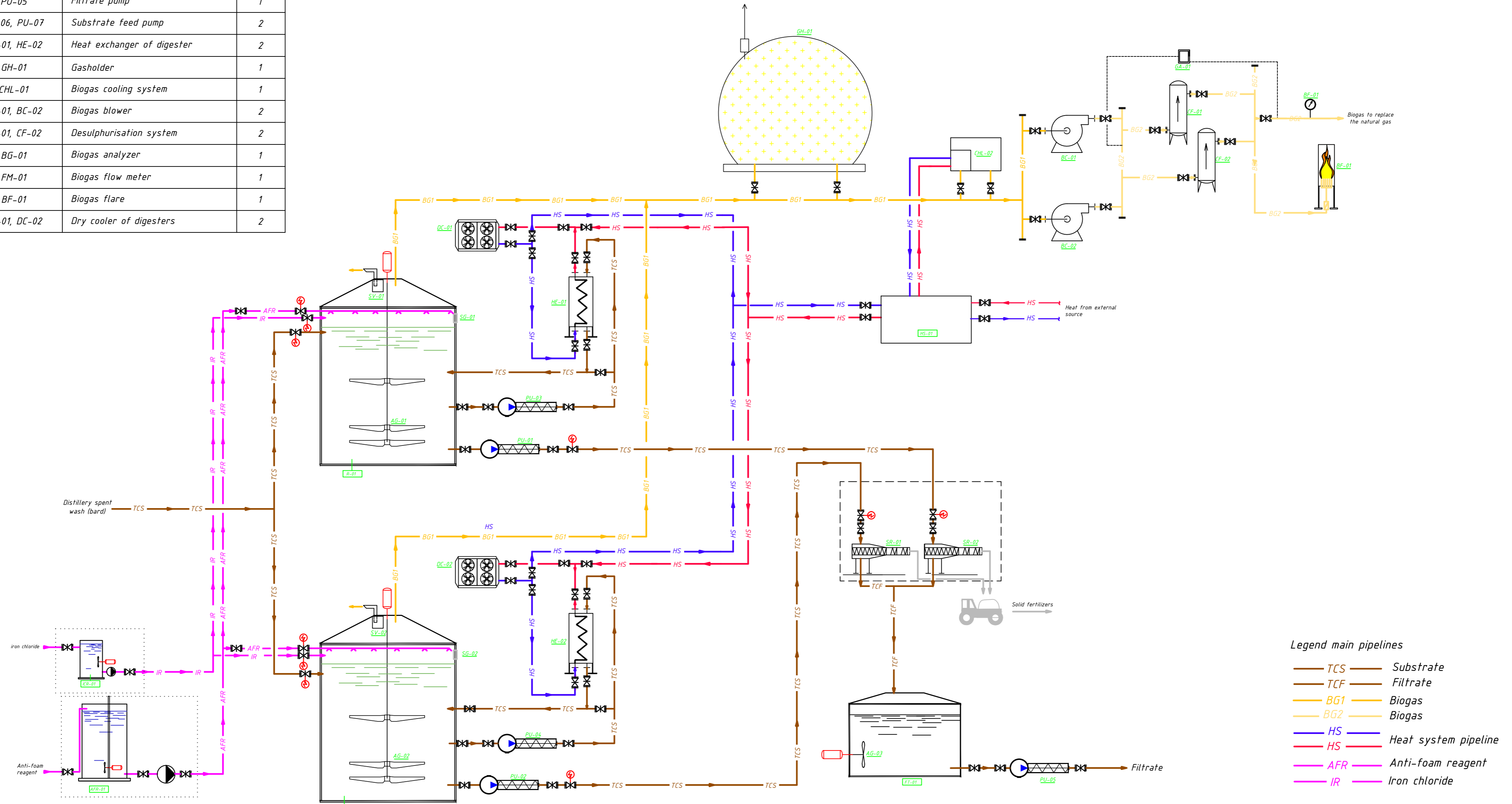

Legend main pipelines

- TCS Substrate
- TCF Filtrate
- BG1 Biogas
- BG2 Biogas
- HS Heat system pipeline
- HS Heat system pipeline
- AFR Anti-foam reagent
- IR Iron chloride

Preliminary layout proposal

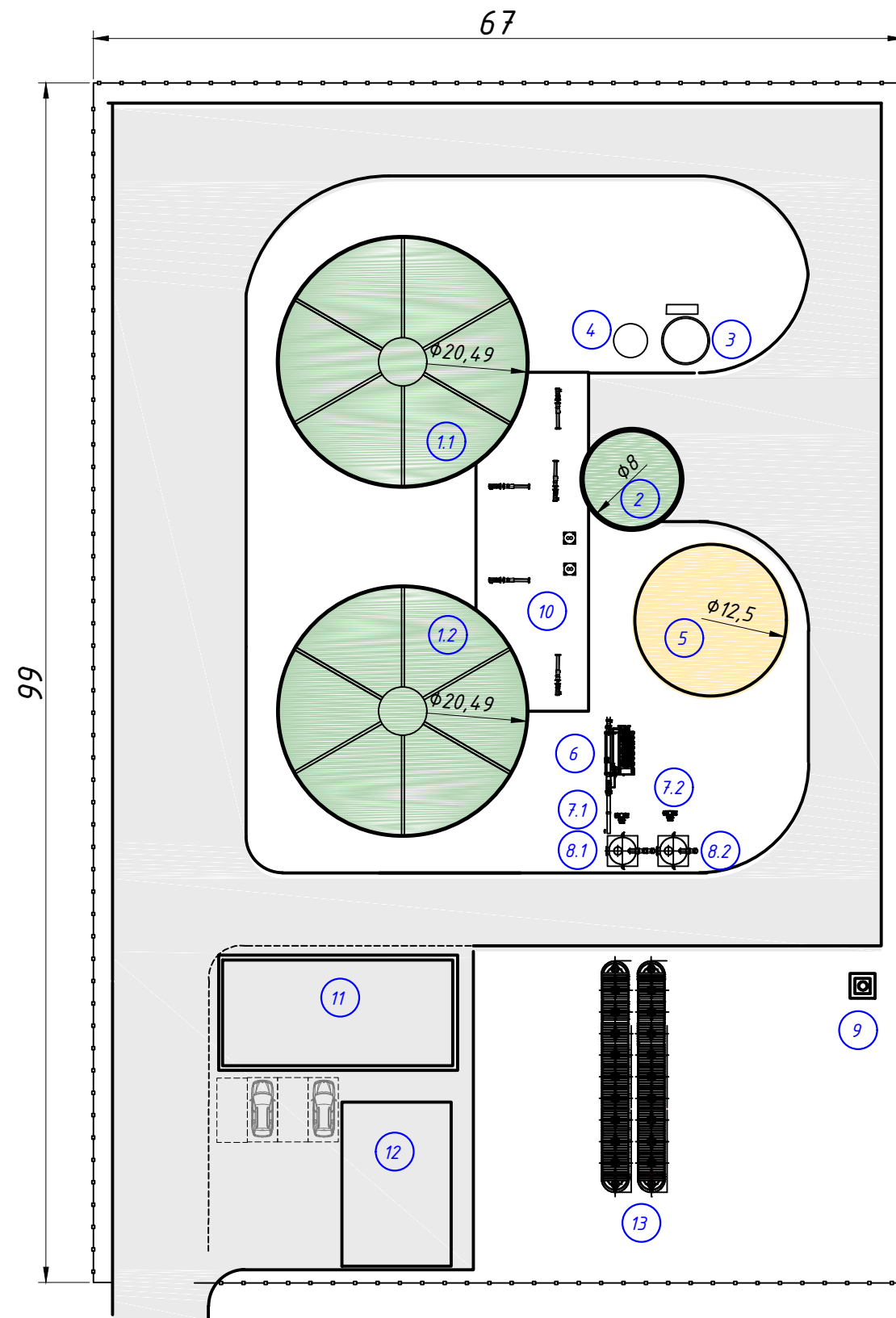

Explication

N/Nº	Name	Note
1.1, 1.2	Reactor	R-01, R-02
2	Filtrat tank	FT-01
3	Anti-foam reagent tank	AFR-01
4	Iron chloride tank	ICR-01
5	Gasholder	GH-01
6	Biogas cooling system	CHL-01
7.1, 7.2	Biogas compressor	BC-01, BC-02
8.1, 8.2	Carbon filter (desulphurization)	CF-01, CF-02
9	Biogas burner	BF-01
10	Equipment room	ER-01
11	Technical room	TR-01
12	Warehouse	WH-01
13	Fire water tank	FWT

#### Appendix 4

Name equipment	Instal. Pow. (kW)	Quantity (pcs)	Total installed power (kW)	Working hours per day	Consumption kWh per day
Digester Vertical agitator	27,0	2	54,0	16,0	864,0
Submersible mixer in filtrate tank	11,0	1	11,0	8,0	88,0
Substrate feed pump to digester	15,0	2	30,0	6,0	180,0
Substrate pump to decanter	15,0	2	30,0	6,0	180,0
Substrate circulation pump	11,0	2	22,0	12,0	264,0
Filtrate pump	15,0	1	15,0	8,0	120,0
Decanter	25,0	2	50,0	8,0	400,0
Anti-foam pump	2,5	1	2,5	1,0	2,5
Iron-ichloride pump	2,0	1	2,0	1,5	3,0
Mixer in anti-foam reagent tank	1,5	1	1,5	3,0	4,5
Mixer in iron chlorided tank	0,3	1	0,3	1,0	0,3
Biogas cooling system	36,0	1	36,0	24,0	864,0
Biogas compressor	16,0	2	32,0	12,0	384,0
Dry cooler (Digester cooling system)	6,0	2	12,0	at t>55°C	
Circulating pump feeding heat carrier	3,5	1	3,5	24,0	84,0
Air blower for double membrane	1,0	1	1,0	24,0	24,0
Circulation pump for supplying at carrier to the digester	0,8	2	1,5	24,0	36,0
Circulating pump feeding hot water at technical building	0,1	1	0,1	only ambient temp +15°C	
Circulation pump for supplying network water to the digester cooling system	2,0	1	2,0	24,0	48,0
Propylene glycol pump station	0,8	1	0,8	0,5	0,4
Desulphurization system compressor	1,5	2	3,0	24,0	72,0
Drinage pump	1,0	2	2,0	0,5	1,0
Lighting of the biogas plant territory	1,0	1	1,0	8,0	8,0
Spot light for digesters inspection windows	0,1	1	0,1	0,5	0,0
Working lighting of switchboard	0,1	1	0,1	0,5	0,1
Total installed power, kW			<b>313</b>		
Total consumed electric energy, kWh per day					<b>3628</b>
Total consumed power, kW					<b>151</b>

## Prices for Zorg' servises and quipment EXW Memmingen, DE

Pos	Name	Number of units	Unit price, EUR	Discounts*	Discounted unit price, EUR	Discounted price sub-total, EUR
A	Project documention	1	87 000	0%	87 000	87 000
B	Supervision	1	50 000	0%	50 000	50 000
C	Startup and training	1	50 000	0%	50 000	50 000
D	Living and travel expences	1	40 000	0%	40 000	40 000
E	Delivery of the equipment	28	2 500	0%	2 500	70 000
F	Laboratory	1	25 000	0%	25 000	25 000
G	Construction	1	1 800 000	0%	1 800 000	1 800 000
I	Filtrate Storage (V=2000 m3)	1	20 000	0%	20 000	20 000
1	Digester Enameled steel tank V=6228 m <sup>3</sup> (including servise stairs, platforms, manholes, pipe flanges, suppotrs, fixing etc.)	2	737 000	0%	737 000	1 474 000
2	Digester central agitator 27kW	2	115 500	0%	115 500	231 000
3	Filtrate Enameled steel tank V=296 m <sup>3</sup> (including servise stairs, platforms, manholes, pipe flanges, suppotrs, fixing etc.)	1	113 000	0%	113 000	113 000
4	Side agitator 11 kW	1	42 300	0%	42 300	42 300
5	Digested substrate pump 15kW	2	23 100	0%	23 100	46 200
6	Circulation pump 11kW	2	22 000	0%	22 000	44 000
7	External heat exchanger	2	93 500	0%	93 500	187 000
8	Biogas blower 1300 m3/h	2	23 100	0%	23 100	46 200
9	Automation and electric cabinet	1	250 000	0%	250 000	250 000
10	Gasholder 860 m3	1	102 000	20%	81 600	81 600
11	Over- and under pressure safeguard	2	5 400	20%	4 320	8 640
12	Sight glasses/viewing windows with projector	2	6 600	20%	5 280	10 560
13	Filtrate supply pump 15kW	1	23 100	10%	20 790	20 790
14	Decanter	2	105 000	10%	94 500	189 000
15	Biogas chiller (Biogas cooling system) 1200 m3/h	1	185 000	20%	148 000	148 000
16	Desulphurization column with active coal 500 kg	2	38 500	20%	30 800	61 600
17	Gas conditioning unit	1	27 500	20%	22 000	22 000
18	Biogas burner 1200 m3/год	1	71 500	20%	57 200	57 200
19	Heat supply station	1	95 700	20%	76 560	76 560
20	Sensors (set)	1	82 500	20%	66 000	66 000
21	Water supply and canalization system	1	61 300	20%	49 040	49 040
22	Gas analyzer	1	28 300	20%	22 640	22 640
23	Dry-cooler	2	28 700	20%	22 960	45 920
24	Iron chloride reagent tank 8m3 system, as a unit.	1	29 700	0%	29 700	29 700
25	Anti-foam reagent tank 40m3 system, as a unit.	1	115 500	0%	115 500	115 500
			<b>TOTAL, EUR</b>			<b>5 580 450</b>



**ZORG**  
**BIOGAS**

Business center "Twin Yards"  
Walter-Gropius-Straße 23,  
DE-80807, München, Germany

Mob. +49 1511 457 29 45 (WhatsApp, Viber, Telegram)

[igor.reddikh@zorg-biogas.com](mailto:igor.reddikh@zorg-biogas.com)  
[www.zorg-biogas.com](http://www.zorg-biogas.com)

[WWW.ZORG-BIOGAS.COM](http://WWW.ZORG-BIOGAS.COM)